

*OK to Release
P. Capriano*

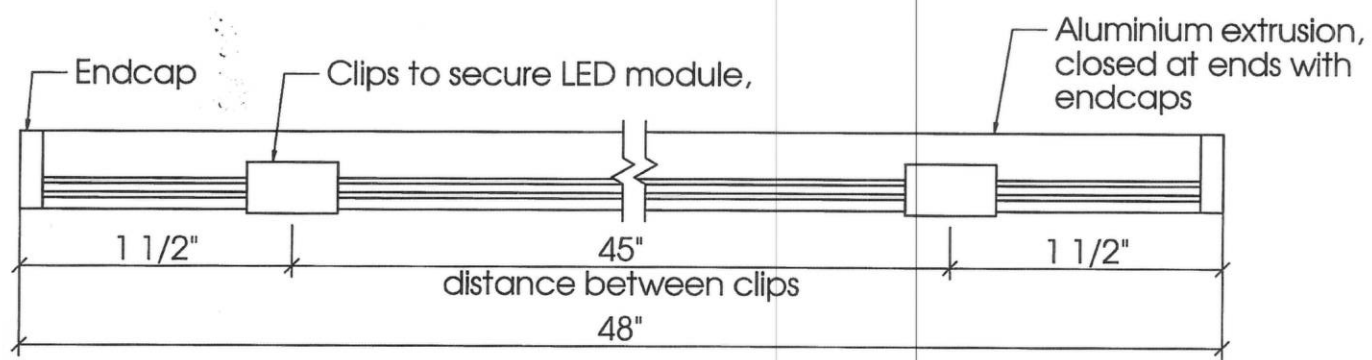

Standard 4' TIE module

TIE 5467
2700K, 5W/foot, 450 lumens/foot
90W remote drivers

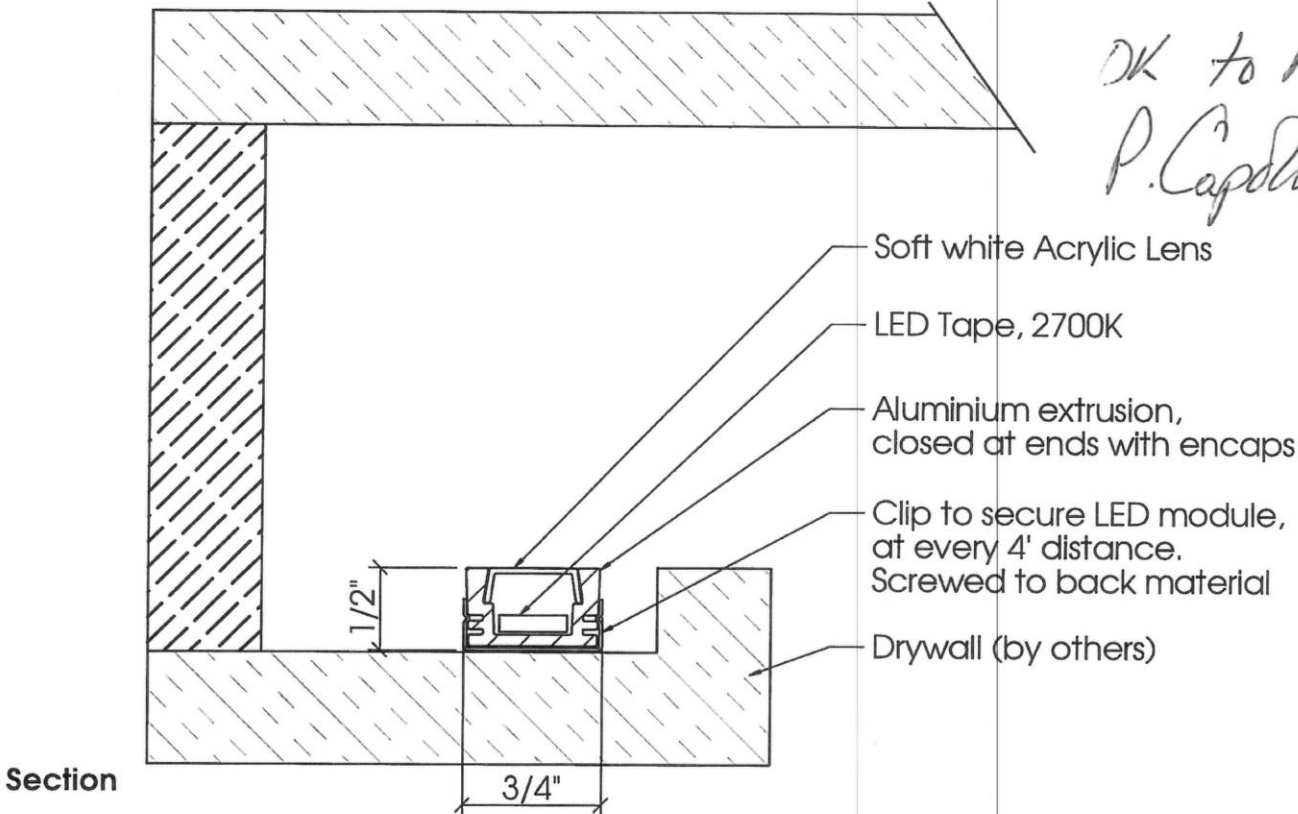
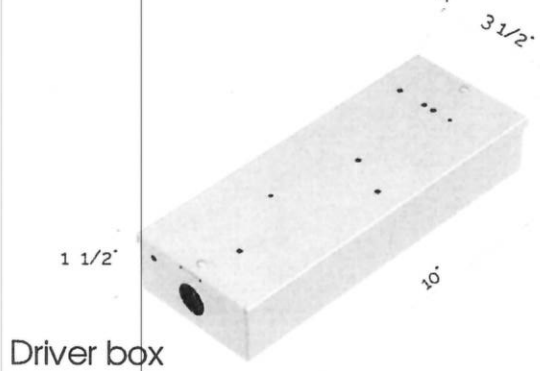

archlit 42 Phoenix Rd., Hopatcong, NJ 07843 P 973.577.4432 www.archlit.com archlit@aol.com

Submittal

Project	Station Village at Avenel Adder NJ	Date	4.10.17
Type/ Description	F3 / TIE	Scale wherever unspecified	Page 1/7
Material	Aluminium	Drawn by Amandeen	

F03. 48 / QTY.= 2 (3.24W/foot, 280 lumens/foot)

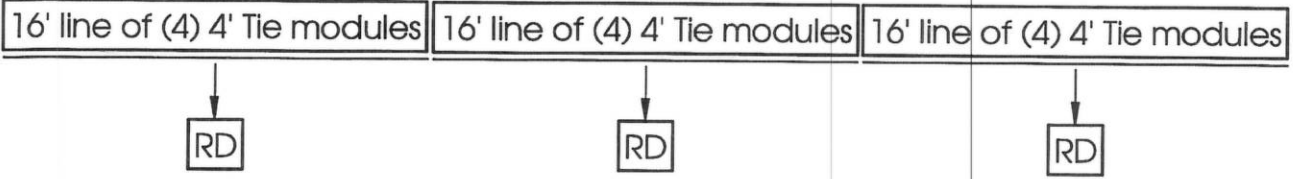

F03. 30 / QTY.= 2 (3.24W/foot, 280 lumens/foot)

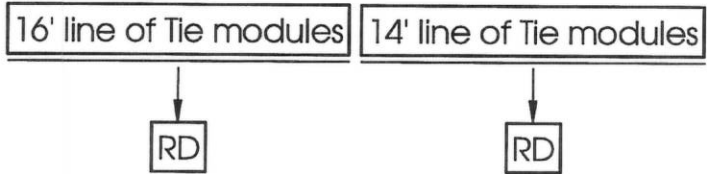

F03. 29 / QTY.= 4 (3.24W/foot, 280 lumens/foot)

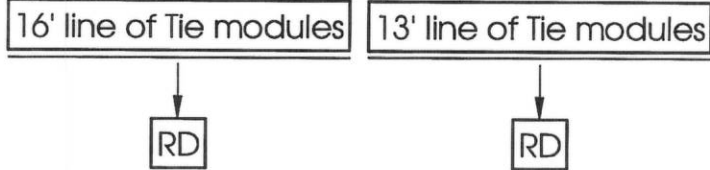

F03. 25 / QTY.= 2 (3.24W/foot, 280 lumens/foot)

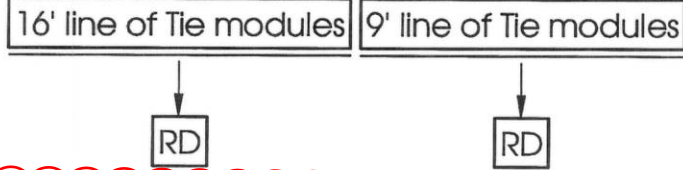

F03. 15 / QTY.= 1 (3.24W/foot, 280 lumens/foot)

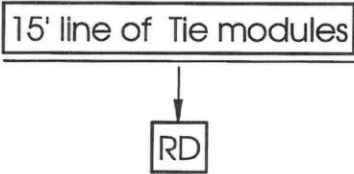

F03. 13 / QTY.= 1 (3.24W/foot, 280 lumens/foot)

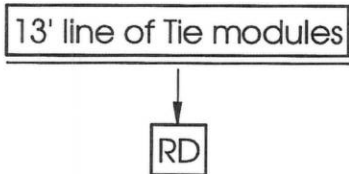

RD 90W driver

Project	Station Village at Avenel Adder NJ	Date	4.10.17
Type/ Description	F3 / TIE	Scale wherever unspecified	Page 2/7
Material	Aluminium	Drawn by Amandeen	